

Platinum[®]
casual living



parasol book 2019

Voorwoord

Functionaliteit, design, bedieningsgemak en robuustheid. Met een Platinum parasol weet u waar u aan toe bent.

De parasol dient primair om optimale bescherming te bieden tegen de zon en dient daarbij zo goed mogelijk naar de zon gericht te kunnen worden. Een Platinum parasol is niet zomaar een parasol. Elke Platinum parasol wordt namelijk met het bedieningsgemak en functionaliteit in gedachten ontworpen. Een Platinum parasol biedt de 'finishing touch' aan uw tuinset en geeft uw tuin een extra zonnige sfeer.

Platinum parasols worden volgens strikte richtlijnen ontworpen. Materialen worden met uiterste zorg geselecteerd om te zorgen dat ze standhouden in lastige weersomstandigheden. De parasols worden volgens de modernste productiemethoden gefabriceerd en aan rigoureuze tests onderworpen voordat ze op de markt worden gebracht.

Wij bieden u een ruime keuze uit verschillende coatings, stofkleuren en stofklassen. Mocht u vragen hebben, voelt u zich dan vrij om contact met ons op te nemen. Wij staan u graag te woord.

Fijne zomer!

Foreword

Functionality, design, ease of use and robustness. A Platinum parasol offers it all.

A parasol should primarily provide optimal protection against the sun and be able to be positioned towards the sun in the best possible way. A Platinum parasol is not just a parasol. Each Platinum parasol is designed with ease of use and functionality in mind. A Platinum parasol offers the finishing touch to any garden furniture set and gives your garden an extra summer atmosphere.

Platinum parasols are designed in accordance with strict guidelines. The materials used are selected with the utmost care to ensure they endure difficult weather conditions. Our parasols are manufactured using the latest production methods and are subjected to rigorous testing before they are introduced to the market.

We offer a choice of various coatings, fabric colors and fabric classes. Feel free to contact us if you have any questions, we will be at your service.

Enjoy the summer!





Inhoud / Content

VOORWOORD / FOREWORD	2
Dutch design / Dutch design	4
Ambacht en kwaliteit / Craftmanship and Quality	6

COLLECTIE / COLLECTION	
Icon	8
Challenger T ²	10
Challenger T ² Oak	12
Challenger T ² White	14
Challenger T ² Glow	16
Challenger T ¹	18
Falcon T ²	20
Falcon T ¹	22
Riva	24
Antigua	26
Parasolvoeten / Parasol bases	28
Parasollicht	31
Ingraaf parasolvoet / In-ground parasol base	32

EXTRA INFORMATIE / EXTRA INFORMATION	
Parasol opties / Parasol options	34
Stofklasse / Material class	35
Lichtechtheid / Colour fastness	36
Overzicht / Overview	37

AEROCOVER® (FLIP BOOK)	1-6
------------------------	-----

Dutch design

Platinum parasols worden bedacht en ontwikkeld door een team van Nederlandse ontwerpers. Het bedieningsgemak en de functionaliteit staan bij elk ontwerp voorop. Door innovatief om te gaan met het ontwerpproces is het dubbel kantelmechanisme ontstaan. De parasol kan hierdoor met gemak traploos in elke gewenste positie gedraaid en gekanteld worden zonder de parasol te verplaatsen. Parasols voorzien van de toevoeging T² (dubbele tilt) zijn uitgevoerd met het dubbele kantelmechanisme.

Dutch design

Platinum parasols are created and developed by a team of Dutch designers. Ease of use and functionality are most important for each design. Using the design process in the most innovative way resulted in the double tilt mechanism.

The sunshade can effortlessly and steplessly be rotated, tilted and twisted in the desired position without having to move your parasol. Parasols with the extension T² (double tilt) are fitted with the double tilt mechanism.

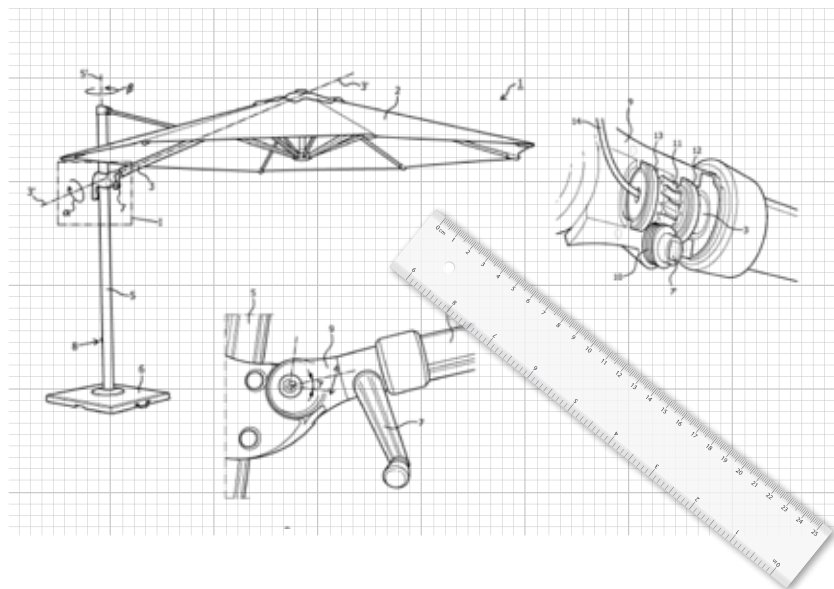



T² System

T² parasols

Kantelen achterover
Kantelen traploos zijwaarts
360 graden draaibaar

T² parasols

Tilt backwards
Tilt stepless sideways
Turn 360 degree





Ambacht en kwaliteit

Platinum parasols staan voor oog voor detail en een lange levensduur. De parasols worden volgens de modernste productiemethoden gefabriceerd en aan rigoureuze tests onderworpen voordat ze op de markt worden gebracht.

Materialen worden met uiterste zorg geselecteerd om er voor te zorgen dat ze standhouden in lastige weersomstandigheden. Platinum biedt keuze in stofklassen en coatings georiënteerd op internationale trends en standaarden.

Onze producten worden gedistribueerd via een breed netwerk verkooppartners en importeurs. Servicegerichtheid is een belangrijk criterium bij de selectie van onze partners.

Craftsmanship and Quality

Platinum parasols stand for attention to detail and durability. Our parasols are manufactured using the latest production methods and are subjected to rigorous testing before they are introduced to the market.

Materials are selected with the utmost care to ensure that they maintain in difficult weather conditions. Platinum offers choice in fabrics and coatings following international trends and standards.

Our products are distributed through a wide network of distributors and importers. Service philosophy is an important criterion in the selection of our partners.

Icon

Modern, chique, stijlvol en groots. De combinatie van een extreem hoog gebruiksgemak en ongekende robuustheid maken de Icon een geliefde parasol voor een groter terras.

De Icon wordt geleverd in grotere maten en is ook dan nog uiterst stabiel door de windstabilisator, de robuuste baleinen en 78 x 78 mm mast. Door het doordachte ontwerp en de toegepaste techniek opent u zelfs de grote maten met gemak. Vervaardigd van weerbestendig aluminium en voorzien van een spuncrylic doek zal deze parasol u jarenlang van dienst zijn.

Modern, chic, stylish and impressive. The combination of extreme ease of use and unprecedented robustness make the Icon the parasol of choice for a larger outdoor area.

The Icon is available in larger sizes. The windstabilizer, robust ribs and 78 x 78 mm pole ensure this sunshade is stable in windy conditions. The sophisticated design and technology can even open the large sizes with ease. Made of weatherproof aluminum and fitted with spuncrylic fabric this sunshade will be at your service for years.



Size	Frame		240 gr. Spuncrylic - Class 4		
	Silver	Anthracite	Faded black	Manhattan	Havana
400 x 300		–	7079P	–	–
400 x 300	–		7078P	7078R	7078Q
350 x 350		–	7077P	–	–
350 x 350	–		7076P	7076R	7076Q

NB: Voor meer parasol opties en technische informatie zie p. 34-37. Parasols worden zonder voet geleverd. Maten kunnen ± 2% afwijken.

Note: For more parasol options and technical information see p. 34-37. Parasol does not include a base. Sizes may vary ± 2%.



Optioneel / *Optional*



360 graden
draaibaar
360 degree
turning



Enkel
kantelbaar
Single tilt



Materiaalklasse
Material class



Gegoten
aluminium
hendel
Cast aluminium
handle



AeroCover
7978



Ingraaf
parasolvoet XL
In-ground
parasol base
XL



Granieten
parasolvoet
150 kg
Granite base
150 kg



LED 7895

Challenger T²

De Challenger T² is het vlaggenschip van onze collectie.

Een stijlvol en luxe design, ontworpen met gebruiksgemak in gedachten. Deze parasol kan met gemak kantelen, 360 graden draaien en naar achteren hellen. Een parasol bedienen was nog nooit zo eenvoudig. Het traploze T2 kantelsysteem is voorzien van een RVS binnenwerk. Hiermee kunt u het doek tegen de zon indraaien en kantelen bij laagstaande zon zonder de parasol te verplaatsen.

Doekspanners aan de baleinen zorgen ervoor dat het doek altijd optimaal gespannen is. De robuuste mast en gegoten aluminium behuizing voor het draaimechanisme staan garant voor een stevige constructie en jarenlang plezier van uw parasol.

The Challenger T² is the flagship of our collection.

A stylish and deluxe design without compromise, engineered with comfort in mind. With the least of effort this parasol can rotate, tilt and twist. The stepless sideways tilt with stainless steel interior allows the parasol to be turned towards the sun without moving the parasol. Operating a sunshade has never been so easy.

Tension springs on the ribs ensure a tight fit of the canopy. The sturdy pole and cast aluminium housing of the turning mechanism guarantee a robust construction and years of pleasure of your parasol.



Size	Frame	300 gr. Polyester - Class 3				240 gr. Spuncrylic - Class 4		
		Black	Taupe	White	Anthracite	Faded black	Manhattan	Havana
300 x 300	Anthracite	7139D	7139E	7139A	7139	7139P	7139R	7139Q
300 x 300		-	-	-	-	7135P	7135R	7135Q
ø 350		7138D	7138E	7138A	7138	7138P	7138R	7138Q

NB: Voor meer parasol opties en technische informatie zie p. 34-37. Parasols worden zonder voet geleverd. Maten kunnen ± 2% afwijken.

Note: For more parasol options and technical information see p. 34-37. Parasol does not include a base. Sizes may vary ± 2%.



Gegoten alu hendel
Cast alu handle



Doekspanners
Tension springs

▶ Product video: [platinum.nl](https://www.platinum.nl)



360 graden draaibaar
360 degree turning



Dubbel kantelbaar
Double tilt



Materiaalklasse
Material class



Materiaalklasse
Material class



Gegoten aluminium hendel
Cast aluminium handle



AeroCover 7970



Ingraaf parasolvoet
In-ground parasol base



Granieten parasolvoet
90 / 120 kg
Granite base
90 / 120 kg



Kruisvoet
Cross base



LED 7895

Optioneel / *Optional*

Challenger T² Oak

De Challenger T² Oak is het nieuwste model in onze collectie. Deze parasol combineert modern gebruiksgemak met een elegante uitstraling; Oak in een eigentijds jasje.

Deze onderhoudsvrije houtlook 'Oak' uitvoering beschikt over dezelfde eigenschappen als de Challenger T² en is daarmee voorzien van doekspanners, een robuuste mast en een sterke gegoten aluminium behuizing.



Dankzij het T² dubbel kantel systeem is deze parasol eenvoudig te bedienen en kunt u altijd schaduw creëren zonder te parasol te verplaatsen. Alle comfort en gebruiksgemak van een Platinum parasol in een moderne eigentijdse uitvoering.

The Challenger T² is the latest addition to our collection. This parasol offers modern comfort with an elegant appearance; Oak in a contemporary design.

This carefree wood look 'Oak' edition offers the same features as the Challenger T² and is equipped with tension springs, a robust pole and a strong cast aluminum housing.

The T² double tilt system ensures it is easy to operate the parasol in all directions and create shadow without moving the parasol. All comfort and ease of use of a Platinum parasol in a modern contemporary design.



Size	Frame	300 gr. Polyester - Class 3	240 gr. Spuncrylic - Class 4
	Oak	White	Faded black
300 x 300		7134A	7134P
ø 350		7136A	7136P

NB: Voor meer parasol opties en technische informatie zie p. 34-37. Parasols worden zonder voet geleverd. Maten kunnen ± 2% afwijken.

Note: For more parasol options and technical information see p. 34-37. Parasol does not include a base. Sizes may vary ± 2%.



Gegoten alu hendel
Cast alu handle



Doekspanners
Tension springs

▶ Product video: platinum.nl



Optioneel / *Optional*



360 graden
draaibaar
360 degree
turning



Dubbel
kantelbaar
Double tilt



Materiaalklasse
Material class



Materiaalklasse
Material class



Gegoten
aluminium
hendel
Cast aluminium
handle



AeroCover
7970



Ingraaf
parasolvoet
In-ground
parasol base



Granieten
parasolvoet
90 / 120 kg
Granite base
90 / 120 kg



Kruisvoet
Cross base



LED 7895

Challenger T² White

Alle comfort, robuustheid en gebruiksgemak van een Platinum parasol. Gecombineerd met een wit frame, voor een frisse uitstraling op uw terras. Dat is de Challenger T² white. Door het stoere en moderne design is deze parasol een aanwinst voor iedere tuin.

Het frame van deze zweefparasol is geheel uit aluminium vervaardigd en doekspanners aan het eind van de baleinen zorgen dat het doek altijd strak gespannen blijft. Tenslotte geven de stevige mast en het sterke gegoten aluminium handvat de Challenger T² de nodige constructie voor jarenlang onbezorgd genieten in de zon.

All comfort, robustness and ease of use of a Platinum parasol. Combined with a white frame, for a fresh look on your terrace. That's the Challenger T² white. This sturdy and modern parasol is an asset to any garden.

The frame of this cantilever parasol is entirely made of aluminum. The tension springs at the end of the ribs ensure a tight fit of the cover. Finally, the sturdy pole and strong cast aluminum handle give the Challenger T² the necessary construction for years of carefree enjoyment in the sun.



Size	Frame	240 gr. Spuncrylic - Class 4		
	White	Faded black	Manhattan	Havana
300 x 300		7135P	7135R	7135Q

NB: Voor meer parasol opties en technische informatie zie p. 34-37. Parasols worden zonder voet geleverd. Maten kunnen ± 2% afwijken.

Note: For more parasol options and technical information see p. 34-37. Parasol does not include a base. Sizes may vary ± 2%.



Gegoten alu hendel
Cast alu handle



Doekspanners
Tension springs

▶ Product video: platinum.nl



Optioneel / *Optional*



360 graden
draaibaar
360 degree
turning



Dubbel
kantelbaar
Double tilt



Materiaalklasse
Material class



Gegoten
aluminium
hendel
Cast aluminium
handle



AeroCover
7970



Ingraaf
parasolvoet
In-ground
parasol base



Granieten
parasolvoet
90 / 120 kg
Granite base
90 / 120 kg



Kruisvoet
Cross base
7805C



LED 7895

Challenger T² Glow

Alle comfort van een luxe Platinum parasol gecombineerd met moderne en sfeervolle LED verlichting. De warm witte verlichting is geïntegreerd in de baleinen en kan zowel naar boven als beneden schijnen. Dit alles is eenvoudig te bedienen. De Glow is snoerloos en voorzien van twee accu's met USB oplader.

De Challenger T² Glow kan traploos draaien, kantelen en overhellen. Het dubbele, traploze kantelmechanisme is voorzien van een rvs binnenwerk en vervaardigd van gegoten aluminium. Gecombineerd met de LED verlichting kunt u op een mooie zomerdag nog langer buiten genieten.

The qualities of a deluxe Platinum parasol combined with modern and atmospheric LED lightning. The warm white lightning is integrated in the ribs en can shine both upwards and downwards. All of this easy to operate. The Glow is wireless and comes with two batteries including a USB charger.

The Challenger T² can tilt stepless sideways, tilt backwards and turn 360 degrees. The double tilt mechanism is equipped with a stainless steel interior and cast aluminium housing. The LED lightning makes it possible to enjoy your summer days even longer.



Size	Frame		
	300 gr. Polyester - Class 3		
	Anthracite	Taupe	Anthracite
300 x 300		7125E	7125
ø 350		7126E	7126

NB: Voor meer parasol opties en technische informatie zie p. 34-37. Parasols worden zonder voet geleverd. Maten kunnen ± 2% afwijken.

Note: For more parasol options and technical information see p. 34-37. Parasol does not include a base. Sizes may vary ± 2%.



Gegoten alu hendel
Cast alu handle

▶ Product video: platinum.nl



Optioneel / *Optional*



360 graden
draaibaar
360 degree
turning



Dubbel
kantelbaar
Double tilt



Materiaalklasse
Material class



Gegoten
aluminium
hendel
Cast aluminium
handle



LED



AeroCover
7970



Ingraaf
parasolvoet
In-ground
parasol base



Granieten
parasolvoet
90 / 120 kg
Granite base
90 / 120 kg



Kruisvoet
Cross base

Challenger T¹

De Challenger T¹ is met zijn stijlvolle uiterlijk en robuuste baleinen een zeer betrouwbare parasol.

De parasol kan achterwaarts kantelen en is 360° draaibaar dankzij het voetpedaal. De gegoten aluminium behuizing en doekspanner garanderen een zorgeloze zomer.

Dit model is ook verkrijgbaar in 400 x 300 cm, geschikt voor gebruik in grotere tuinen.

The Challenger T¹ with its stylish look and sturdy ribs is a highly reliable parasol.

The parasol can be tilted backwards and with the foot pedal you may turn it 360 degrees. The strong cast aluminium handle and tension springs on the ribs ensure a carefree summer.

The Challenger T¹ is also available in 400 x 300 cm for larger outdoor areas.



Size	Frame	300 gr. Polyester - Class 3				240 gr. Spuncrylic - Class 4		
		Black	Taupe	White	Anthracite	Faded black	Manhattan	Havana
400 x 300	Anthracite	-	-	-	-	7143P	7143R	7143Q
300 x 300		7142D	7142E	7142A	7142	7142P	7142R	7142Q
ø 350		7141D	7141E	7141A	7141	7141P	7141R	7141Q

NB: Voor meer parasol opties en technische informatie zie p. 34-37. Parasols worden zonder voet geleverd. Maten kunnen ± 2% afwijken.

Note: For more parasol options and technical information see p. 34-37. Parasol does not include a base. Sizes may vary ± 2%.

Gegoten alu hendel
Cast alu handle



Doekspanners
Tension springs





Optioneel / *Optional*



360 graden
draaibaar
360 degree
turning



Enkel
kantelbaar
Single tilt



Materiaalklasse
Material class



Materiaalklasse
Material class



Gegoten
aluminium
hendel
Cast aluminium
handle



AeroCover
7970 / 7978



Ingraaf
parasolvoet
In-ground
parasol base



Granieten
parasolvoet
90 / 120 kg
Granite base
90 / 120 kg



Kruisvoet
Cross base



LED 7895

Falcon T²

De Falcon T² serie mag met recht uniek genoemd worden. Een zweefparasol die wat minder ruimte behoeft, maar wel alle functionaliteit en bedieningsgemak biedt waar Platinum parasols bekend om staan.

Uitgevoerd in de unieke afmeting 2,7 x 2,7 meter is de Falcon T² parasol uitermate geschikt voor een compact terras. De Falcon T² parasol is eenvoudig 360° draaibaar en kan zowel achterwaarts als zijwaarts kantelen. Zo zit u altijd uit de zon zonder de parasol te verplaatsen. De Falcon is eenvoudig in gebruik.

The Falcon T² series are unique in its kind. A cantilever parasol which does not need so much space, yet still offers all functionality and is easy in use.

In the unique 2,7 x 2,7 meter size the Falcon T² parasol is very suitable for a smaller terrace. The Falcon T² parasol can turn 360 degrees and can tilt both backwards and sideways in any position. The Falcon is easy in use.



Size	Frame	220 gr. Polyester - Class 2	
	Anthracite	Taupe	Anthracite
270 x 270		7093E	7093

NB: Voor meer parasol opties en technische informatie zie p. 34-37. Parasols worden zonder voet geleverd. Maten kunnen ± 2% afwijken.

Note: For more parasol options and technical information see p. 34-37. Parasol does not include a base. Sizes may vary ± 2%.





Optioneel / Optional



360 graden
draaibaar
360 degree
turning



Dubbel
kantelbaar
Double tilt



Materiaalklasse
Material class



AeroCover
7970



Ingraaf
parasolvoet
In-ground
parasol base



Granieten
parasolvoet
90 kg
Granite base
90 kg



LED 7895

Falcon T¹

De Falcon T¹ is een klassiek model binnen de Platinum collectie zweefparasols. De volledig aluminium mast en stalen baleinen zorgen voor een stevige constructie.

De Falcon T¹ parasol in de unieke afmeting 3 x 2 meter is ideaal te gebruiken in combinatie met een rechthoekige tuintafel. Deze parasol is eenvoudig 360° draaibaar en achterwaarts kantelbaar.

The Falcon T¹ is the classic model of the Platinum free-arm parasols. The all-aluminium pole and steel ribs give the parasol a sturdy construction.

The Falcon T¹ parasols in the unique 3 x 2 meter size fits perfectly with a rectangular table. The parasol can turn 360 degrees and tilt backwards. The Falcon is easy in use.



Size	Frame	220 gr. Polyester - Class 2	
	Anthracite	Taupe	Anthracite
250 x 250		7091E	7091
300 x 200		7089E	7089
ø 350		7088E	7088

NB: Voor meer parasol opties en technische informatie zie p. 34-37. Parasols worden zonder voet geleverd. Maten kunnen ± 2% afwijken.

Note: For more parasol options and technical information see p. 34-37. Parasol does not include a base. Sizes may vary ± 2%.





Optioneel / *Optional*



360 graden
draaibaar
360 degree
turning



Enkel
kantelbaar
Single tilt



Materiaalklasse
Material class



AeroCover
7970



Ingraaf
parasolvoet
In-ground
parasol
base



Granieten
parasolvoet
90 kg
Granite base
90 kg



Kruisvoet
Cross base



LED 7895

Riva

De Riva parasol heeft een moderne, strakke uitstraling. De Riva is uitgerust met een stevige deelbare mast, easy-up opdraaimechanisme en doekspanners voor een extra strakke uitstraling. Met het kantelsysteem creëert u altijd schaduw in uw tuin of op het balkon.

Met een ruime keuze uit afmetingen en kleuren is er voor elk wat wils. De ø 3,5 meter en ø 4 meter parasols hebben een dickere mast en geen knikstelsysteem zodat ze beter bestand zijn tegen weersinvloeden.

The Riva parasol has a modern look. The Riva is fitted with a solid separable pole, easy-up handle and tension springs to create a smooth design. The handy tilting system enables you to create shadow in your garden or on the balcony.

The wide variety in sizes and colours always offers you enough choice. The ø 3,5 meter and ø 4 meter parasols have a thicker pole and no tilt system to make them more weather resistant.



Doekspanners
Tension springs

Size	Frame	220 gr. Polyester - Class 1											240 gr. Spuncrylic - Class 4		
		Anthracite	Black	Blue	Apple	Taupe	Red	White	Ecru	Anthracite	Light grey	Fuchsia	Olive	Faded black	Manhattan
ø 250		7100D	7100G	-	7100E	7100M	7100A	7100B	7100	7100C	-	7100T	-	-	-
ø 270		7102D	-	-	7102E	-	7102A	-	7102	-	-	-	-	-	-
ø 300		7104D	7104G	7104N	7104E	7104M	7104A	7104B	7104	7104C	7104K	7104T	7104P	7104R	7104Q
ø 350		7110D	-	-	7110E	-	7110A	-	7110	-	-	-	-	-	-
ø 400		7112D	-	-	7112E	-	7112A	-	7112	-	-	-	-	-	-
250 x 250		7106D	-	-	7106E	-	7106A	-	7106	-	-	-	-	-	-
300 x 200		7108D	-	-	7108E	-	7108A	-	7108	-	-	-	-	-	-

NB: Voor meer parasol opties en technische informatie zie p. 34-37. Parasols worden zonder voet geleverd. Maten kunnen ± 2% afwijken.

Note: For more parasol options and technical information see p. 34-37. Parasol does not include a base. Sizes may vary ± 2%.



Optioneel / *Optional*



Enkel
kantelbaar
Single
tiit



Materiaalklasse
Material class



Materiaalklasse
Material class



Easy-up
draaisysteem
Easy-up handle



AeroCover
7982 / 7984



Granieten
parasolvoet
30 / 40 / 60 kg
Granite base
30 / 40 / 60 kg

Antigua

Een klassiek model welke in de tijd ongewijzigd is gebleven.

Het 220 grams polyester doek en opdraaimechanisme geven de Antigua het comfort en de betrouwbaarheid welke u van een Platinum parasol mag verwachten. De volant geeft extra schaduw bij een laagstaande zon.

A classic model which has remained unchanged over time.

The 220 grams polyester fabric and handle gives the Antigua the comfort and reliability you can expect from a Platinum parasol. The volant creates extra shade when the sun is low on the horizon.



Size	Frame	220 gr. Polyester - Class 1			
		Black	Taupe	White	Anthracite
ø 300		7720D	7720E	7720A	7720

NB: Voor meer parasol opties en technische informatie zie p. 34-37. Parasols worden zonder voet geleverd. Maten kunnen ± 2% afwijken.

Note: For more parasol options and technical information see p. 34-37. Parasol does not include a base. Sizes may vary ± 2%.



Optioneel / *Optional*



Materiaalklasse
Material class



Easy-up
draaisysteem
Easy-up handle



AeroCover
7982



Granieten
parasolvoet
40 kg
Granite base
40 kg



Parasolvoeten

Platinum produceert kwaliteits parasolvoeten. Onze parasolvoeten voor middenstok parasols zijn uitgevoerd met roestvrij stalen buizen en waterafvoer.

Door het unieke adapter systeem staan parasols met een buisdiameter tot en met 48mm altijd in het midden en rechtop. Het anti-slip systeem zorgt ervoor dat de parasol niet kan tollen in de wind.

De natuurstenen parasolvoeten zijn vervaardigd van speciaal geselecteerd graniet en worden gepolijst of gevlamd aangeboden. Met de optionele zwenkwielen maakt u uw parasol mobieler in de tuin.

Parasol bases

Platinum produces quality parasol bases. Our parasol bases for center pole parasols are fitted with stainless steel tubes and water drainage.

The unique adapter system ensures parasols with a tube diameter up to 48mm are always kept straight. The anti-slip system ensures that the parasol can not spin in the wind.

Granite parasol bases are specially selected and offered in polished or burned finish. The optional swivel castors makes your parasol more mobile in the garden.

Rome



Art. nr.	Weight	Material	Finish
6007	30 kg	Granite	Black polished
6008	40 kg	Granite	Black polished
6060	60 kg	Granite	Black polished

Milano



Art. nr.	Weight	Material	Finish
6047	90 kg	Granite	Black polished

Rome Wheels



Art. nr.	Weight	Material	Finish
6009	40 kg	Granite	Black polished

Modena



Art. nr.	Weight	Material	Finish	Wheels
6082	90 kg	Granite	Black polished	Standard
6088	90 kg	Granite	Black polished	XL wheels
6083	120 kg	Granite	Black polished	XL wheels

Modena



Art. nr.	Weight	Material	Finish	Wheels
6086	150 kg	Granite	Black polished	XL wheels

Sorrento



Art. nr.	Weight	Material	Finish	Wheels
6094	90 kg	Granite	Black burned	Standard

Arezzo



Art. nr.	Weight	Material	Finish
6076	90 kg	Granite	Black burned

Salerno



Art. nr.	Weight	Material	Finish	Wheels
6016	90 kg	Granite	Grey hammered	Standard
6018	120 kg	Granite	Grey hammered	XL wheels

Parasol light

LED multicolour

LED lamp voor Platinum zweefparasols.
Met afstandsbediening en USB oplader.
In te stellen in 4 verschillende standen en 10
verschillende kleuren.

*LED light for Platinum free arm parasols.
Including remote control and USB charger. 4
different modes and 10 different colours.*

Art. nr. 7895





- **Makkelijk te plaatsen, zonder beton**
- **Meer ruimte op uw terras**
- **Geen parasol op uw terras als u uw parasol niet gebruikt**

- **Easy to install, no concrete needed**
- **More space on your terrace**
- **No parasol base in sight when parasol is not in use**

Ingraaf parasolvoet

In-ground parasol base

Geschikt voor onder andere:

- Platinum parasols Challenger, Deltawing en Falcon.
- Zweefparasols tot 3 x 3 of ø 3,5 m.
De XL versie is voor grotere maten geschikt.
- Voor parasols met gatafstand 95/113 mm.
Voor afwijkende maten kunt u de apart verkrijgbare adapterplaat gebruiken.

Suitable for among others:

- *Platinum Challenger, Deltawing and Falcon.*
- *Free arm parasols up to 3 x 3 or ø 3.5 m.*
XL version suitable for larger sizes.
- *For parasols with hole distance 95/113 mm.*
For alternative hole distance use our adaptor plate.

4 simpele stappen / 4 simple steps

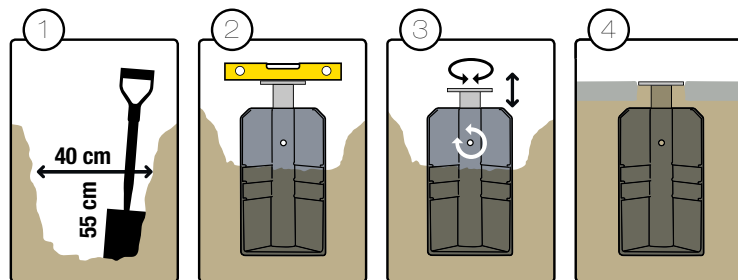

Art. nr. 6905: In-ground base XL



Art nr 6900: In-ground base

Parasol options

Een Platinum parasol combineert functionaliteit met design en zorgt voor de "finishing touch" in uw tuin. Onze parasols zijn verkrijgbaar in meerdere uitvoeringen en afmetingen. Hierbij heeft u de keuze uit verschillende coatings en stofklassen.

Parasol options

A Platinum parasol combines functionality with design and also adds the finishing touch to your garden. Our parasols come in various shapes and sizes. Different options are offered with each parasol for you to choose from.

Silver

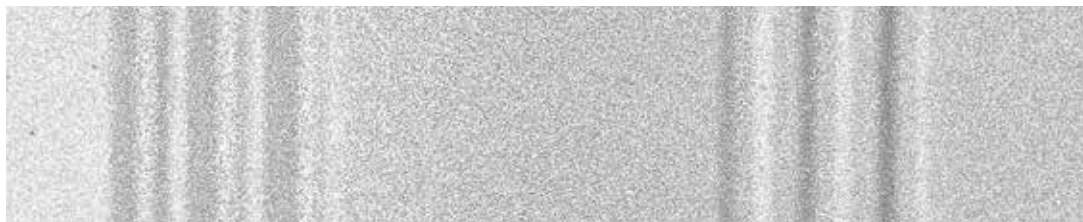

Anthracite



White

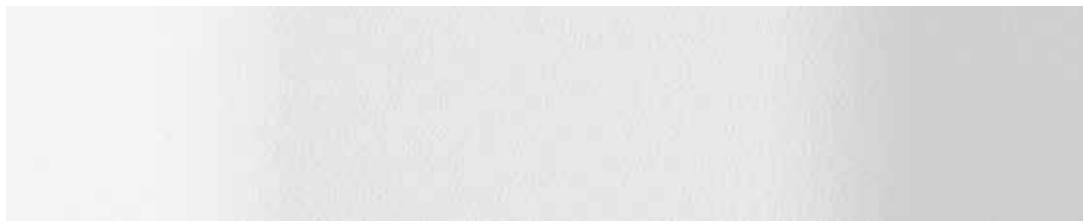

Oak



Stofklasse 1 / Material class 1:

100% polyester, 220 grams/m², lichtechtheid 5, UPF 35+, waterafstotend en vuilbestendig.
100% polyester, 220 grams/m², lightfastness 5, UPF 35+, water-repellent and dirt resistant.

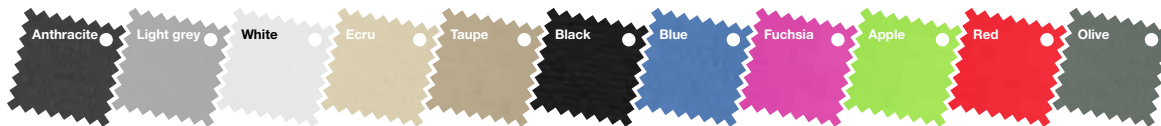

Stofklasse 2 / Material class 2:

100% polyester, 220 grams/m², lichtechtheid 5-6, UPF 35+, PA coating, waterafstotend en vuilbestendig.
100% polyester, 220 grams/m², colour fastness 5-6, UPF 35+, PA coated, water-repellent and dirt resistant.

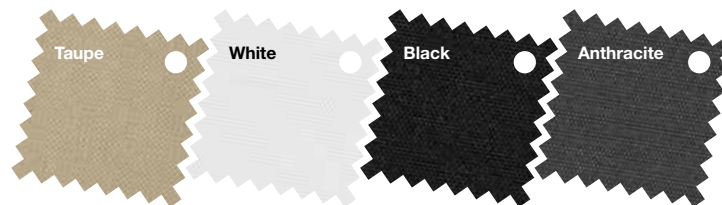

Stofklasse 3 / Material class 3:

100% polyester, 300 grams/m², lichtechtheid 5-6, UPF 35+, PU coating, waterafstotend en vuilbestendig.
100% polyester, 300 grams/m², colour fastness 5-6, UPF 35+, PU coated, water-repellent and dirt resistant.

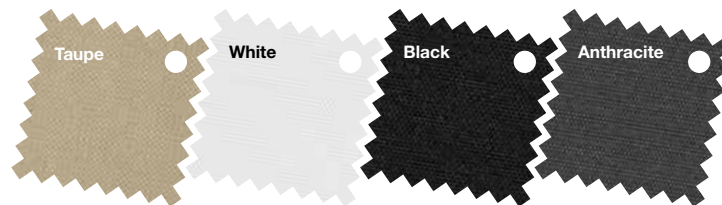

Stofklasse 4 Premium / Material class 4 Premium:

100% spuncrylic, 240 grams/m², solution dyed, lichtechtheid 7, UPF 50+, waterafstotend en vuilbestendig. Optimale bescherming tegen UV-straling.
100% spuncrylic, 240 grams/m², solution dyed, colour fastness 7, UPF 50+, water-repellent and dirt resistant. Optimal protection against UV rays.



Lichtechtheid

De stof van een parasol verkleurt met de tijd wanneer deze permanent wordt blootgesteld aan de zon. Hoe snel en hoeveel hangt af van de kwaliteit van de stof. Platinum biedt stoffen aan in de klassen. Bij een hogere stofklasse is de lichtechtheid beter met als gevolg een langere periode tot eerst merkbare verkleuring. Een doek van stofklasse 2 heeft een lichtechtheid van 80-160 dagen bij blootstelling aan de zon. Stofklasse 4 vertoont initiële kleurveranderingen na ongeveer 350 dagen direct zonlicht. Wij adviseren u bij niet-gebruik van een parasol altijd een beschermhoes te gebruiken om de levensduur van uw parasol te verlengen.

Colour fastness









When a sunshade is exposed to the sun, the fabric will fade over time. How quickly and to what extent depends on the fabric quality. Platinum offers fabrics in classes 1 up to 4. A higher material class results in a better colour fastness with a longer period until first noticeable fading. Material class 2 offers a colour fastness of 80-160 days in the sun. Material class 4 shows initial colour changes after ca 350 days of solar radiation. To extend the lifespan of your parasol we recommend to always use a storage cover when your parasol is not in use.



UV protectie

Alle parasols bieden bescherming tegen de zon, maar niet alle parasols bieden bescherming tegen UV straling. Platinum parasoldoeken bieden een hoge bescherming tot UPF klasse 50+ op een schaal van 15 tot 50+.

UV protection

Every sunshade offers protection from the sun, but not all protect against UV rays. Platinum sunshades filter and protect against UV rays with a UPF class up to 50+ on a scale from 15 to 50+.

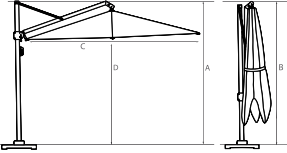
	8	7	6	5	4	3	2	1
								
Originele kleur	uitmuntend	uitstekend	zeer goed	goed	redelijk goed	matig	gering	zeer gering
Stofklasse		4	3	2 1				
Eerste merkbare kleurverandering na	700 dagen	350 dagen	160 dagen	80 dagen	40 dagen	20 dagen	10 dagen	5 dagen
Original colour	outstanding	excellend	very good	good	rather good	moderate	poor	very poor
Material class		4	3	2 1				
First noticeable fading after	700 days	350 days	160 days	80 days	40 days	20 days	10 days	5 days

Parasol Parasol	Doekmaat Cover size	Mast Pole	A Hoogte geopend Height opened	B Hoogte gesloten Height closed	C Oppervlakte Area covered	D Vrije hoogte Free height	AeroCover® art. nr.	Minimum advies gewicht Minimum advised weight		
Icon	350 x 350 cm	7.8 x 7.8 cm	289 cm	295 cm	12.3 m ²	206 cm	7978	150 kg / in-ground XL		
	400 x 300 cm	7.8 x 7.8 cm	289 cm	295 cm	12.0 m ²	211 cm	7978	150 kg / in-ground XL		
Challenger T ²	300 x 300 cm	8.6 x 5.3 cm	265 cm	265 cm	9.0 m ²	198 cm	7970	90 kg / in ground base		
	Ø 350 cm	8.6 x 5.3 cm	262 cm	265 cm	9.62 m ²	205 cm	7970	90 kg / in ground base		
Challenger T ¹	300 x 300 cm	8.6 x 5.3 cm	262 cm	265 cm	9.0 m ²	200 cm	7970	90 kg / in ground base		
	400 x 300 cm	8.6 x 5.3 cm	257 cm	270 cm	12.0 m ²	200 cm	7978	120 kg /in ground XL		
	Ø 350 cm	8.6 x 5.3 cm	257 cm	270 cm	9.62 m ²	196 cm	7970	90 kg / in ground base		
Falcon T ²	270 x 270 cm	6.7 x 5.0 cm	245 cm	248 cm	7.29m ²	194 cm	7970	90 kg / in ground base		
Falcon T ¹	250 x 250 cm	6.7 x 5.0 cm	266 cm	264 cm	6.25 m ²	209 cm	7970	90 kg / in ground base		
	300 x 200 cm	6.7 x 5.0 cm	238 cm	241 cm	6.0 m ²	190 cm	7970	90 kg / in ground base		
	Ø 300 cm	6.7 x 5.0 cm	243 cm	246 cm	7.1 m ²	196 cm	7970	90 kg / in ground base		
Riva	Ø 250 cm	Ø 3.8 cm	232 cm	232 cm	4.91 m ²	193 cm	7982	30 kg		
	Ø 270 cm	Ø 3.8 cm	240 cm	240 cm	5.72 m ²	193 cm	7982	40 kg		
	Ø 300 cm	Ø 3.8 cm	238 cm	238 cm	7.1 m ²	193 cm	7982	40 kg		
	Ø 350 cm	Ø 4.8 cm	262 cm	262 cm	9.62 m ²	202 cm	7984	60 kg		
	Ø 400 cm	Ø 4.8 cm	272 cm	272 cm	12.56 m ²	210 cm	7984	60 kg		
	250 x 250 cm	Ø 3.8 cm	258 cm	258 cm	6.25 m ²	206 cm	7984	60 kg		
	300 x 200 cm	Ø 3.8 cm	256 cm	256 cm	6.0 m ²	205 cm	7984	60 kg		
Antigua	Ø 300 cm	Ø 3.8 cm	231 cm	231 cm	7.1 m ²	200 cm	7982	40 kg		



AeroCover[®]
BREATHABLE PROTECTION



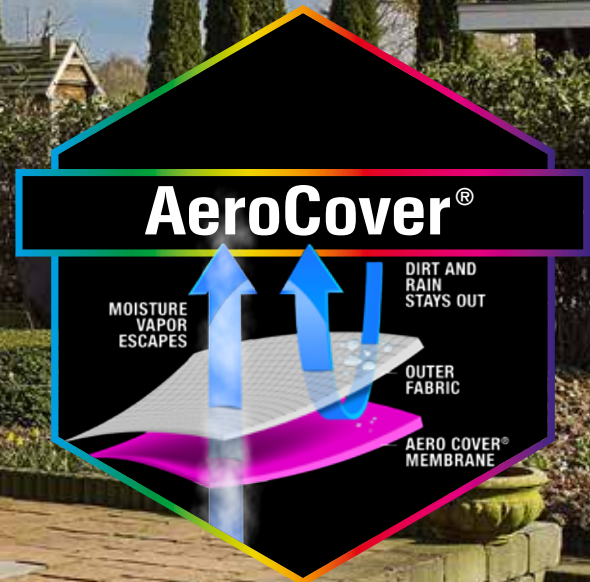

Ademen is belangrijk

Door temperatuurverschillen is het onvermijdelijk dat condensvorming ontstaat. AeroCovers® zijn voorzien van een ademend membraan. Deze helpt vocht naar buiten te transporteren en houdt tegelijkertijd vuil, stof en regen van buitenaf tegen. Dit is belangrijk om schimmelvorming op uw tuinmeubel of parasol tegen te gaan en de levensduur van uw tuinmeubel te verlengen.



Hoge kleurechtheid

AeroCovers® zijn solution dyed en door-en-door gekleurd. Hierdoor hebben AeroCovers® een hoge kleurechtheid, level 7 op de grey-wool schaal. Standaard hoezen verkleuren veel sneller.

Het alternatief voor PVC

Het probleem van PVC en PU hoezen is dat deze niet ademen. Ondanks dat ze dit vaak claimen, kunnen PVC hoezen alleen ademen als ze voorzien zijn van ventilatiegaten. Door deze gaten kan vuil en stof binnen komen.

Dit is juist wat u probeert te voorkomen! PVC wordt hard bij lage temperaturen waardoor ze vaak stuk gaan.

AeroCovers® blijven ook bij lage temperaturen soepel. PVC is slecht voor het milieu. AeroCovers® zijn vervaardigd van milieuvriendelijke materialen en kunnen gerecycled worden.

Goede pasvorm

AeroCovers® zijn voorzien van een rijgkoord met stopper aan twee kanten van de hoes voor een goede pasvorm.

De L-hoezen zijn voorzien van een extra gesp.

Licht gewicht en sterk

AeroCovers® zijn vervaardigd van lichtgewicht ripstop polyester. Hierdoor zijn ze makkelijk hanteerbaar en nemen ze weinig ruimte in wanneer niet in gebruik. Alle tuinmeubel- en loungesethoezen zijn voorzien van een handig opbergtas welke vastzit aan de hoes.

Gemak

AeroCovers® parasolhoezen zijn voorzien van een stok in de hoes. Hiermee kunt de hoes ook makkelijk over een hoge parasol krijgen zonder trap. De kussentassen hebben versterkte handvaten en een dubbele rits zodat u makkelijk bij de kussen kunt.

Breathing is important

Temperature changes cause condensation to be inevitable. AeroCovers® feature a breathable membrane. This membrane transports condensation outside and prevents water, dust and dirt from getting in at the same time. It is important to prevent mold and mildew from building up and extend the life of your garden furniture or parasol.



High colour fastness

AeroCovers® fabrics are solution dyed and coloured throughout. This process gives AeroCovers® a high colour fastness. Level 7 on the grey-wool scale. Standard covers fade very fast.

The alternative for PVC

The trouble with PVC / Vinyl covers is that they do not breathe. Though manufacturers claim this, pvc covers can only breathe through air vents built into these covers. These air vents allow dirt and dust to come in. This is just what you are trying to avoid! Vinyl / PVC becomes hard with low temperatures and eventually break because of this. AeroCovers stay flexible, also with low temperatures. Vinyl / PVC is also bad for our earth. AeroCovers® are made of environmentally friendly materials that can be recycled after their useful life.

Good fit

AeroCovers® feature sewn-in cords with 2 stoppers at 2 sides of the cover. This way it is easy to tighten your cover. L-shape covers are fitted with and an extra buckle.

Lightweight and strong

AeroCovers® are made from lightweight ripstop polyester. They are easy to handle and take up little space when not in use. All garden furniture and lounge set covers come with a handy storage bag attached to the cover.

Ease of use

AeroCovers® parasol covers are fitted with a sewn-in fibre glass rod. You can easily cover your parasol without using a stepladder. Our cushion storage bags have reinforced handles and double zippers for easy access.

Lounge



Lounge sets Square/ Rectangular			
210x200xH70	7932	€ 72,95	
220x220xH70	7995	€ 79,95	
235x235xH70	7933	€ 89,95	
250x200xH70	7996	€ 87,95	
255x255xH70	7934	€ 94,95	
270x210xH70	7938	€ 89,95	
275x275xH70	7937	€ 99,95	
300x250xH70	7939	€ 99,95	
300x300xH70	7935	€ 109,95	
400x300xH70	7936	€ 129,95	
300x250xH70	7939	€ 99,95	
220x220xH70	7995	€ 79,95	
250x200xH70	7996	€ 87,95	



Lounge L-shape- High backrest- 90° corner		
270x210x85xH65/90 Links	7990	€ 99,95
270x210x85xH65/90 Rechts	7991	€ 99,95



Lounge benches		
170x100xH70	7931	€ 47,95
205x100xH70	7961	€ 52,95
250x100xH70	7963	€ 64,95



Lounge chairs		
100x100xH70	7960	€ 39,95
75x78xH65/90	7965	€ 39,95
75x78xH65/110	7966	€ 39,95



Lounge L-shape- Low backrest- trapeze corner		
270x270x100xH70	7951	€ 89,95
300x300x100xH70	7952	€ 99,95



Lounge L-shape- High backrest - trapeze corner		
255x255x90xH65/90	7955	€ 97,95
270x270x90xH65/90	7956	€ 99,95
300x300x90xH65/90	7957	€ 114,95



Lounge beds		
210x75xH40	7964	€ 44,95



Lounge L-shape- Platform		
255x255x90xH30/45/70	7880	€ 97,50
275x275x90xH30/45/70	7881	€ 99,95
325x255x90xH30/45/70 Links	7882	€ 114,95
325x255x90xH30/45/70 Rechts	7883	€ 99,95
350x275x90xH30/45/70 Links	7884	€ 109,95
350x275x90xH30/45/70 Rechts	7885	€ 109,95
300x300x90xH30/45/70	7886	€ 109,95
375x300x90xH30/45/70 Links	7887	€ 119,95



Lounge L-shape- Low backrest- 90° corner		
220x220x90xH70	7944	€ 69,95
235x235x100xH70	7940	€ 74,95
255x255x100xH70	7941	€ 82,95
270x270x100xH70	7942	€ 89,95
300x300x100xH70	7943	€ 99,95
220x220x90xH70	7944	€ 74,95
330x255x100xH70 Links	7946	€ 99,95
330x255x100xH70 Rechts	7947	€ 99,95
355x275x100xH70 Links	7948	€ 109,95
355x275x100xH70 Rechts	7949	€ 109,95

Garden Furniture



Dining sets- Square/ Rectangular		
130x130xH85	7913	€ 49,95
160x150xH85	7914	€ 59,95
180x190xH85	7920	€ 74,95
200x190xH85	7915	€ 79,95
220x190xH85	7921	€ 84,95
240x190xH85	7916	€ 89,95
305x190xH85	7918	€ 99,95



Garden tables		
160x100xH70	7922	€ 49,95
180x110xH70	7923	€ 54,95
200x110xH70	7924	€ 59,95
220x110xH70	7925	€ 64,95
240x110xH70	7926	€ 69,95
300x110xH70	7928	€ 79,95



Dining sets- Round		
Ø 150xH85	7911	€ 59,95
Ø 200xH85	7912	€ 74,95
Ø 250xH85	7919	€ 99,95
Ø 320xH85	7917	€ 119,95



Garden benches		
130x75xH65/85	7908	€ 44,95
160x75xH65/85	7909	€ 49,95



Hang chairs		
Ø 100x200	7969	€ 49,95



Stacking chairs		
67x67xH80/110	7962	€ 29,95

Cushions



Cushions bags		
80x80xH60	7900	€ 32,95
125x32xH50	7901	€ 27,95
175x80xH60	7902	€ 54,95
200x75xH60	7903	€ 59,95

Barbecues and fire tables



Fire tables Square/ Rectular		
60x60xH45	9100	€ 39,95
64x64xH65	9102	€ 39,95
74x74xH60	9104	€ 39,95
82x82xH50	9106	€ 44,95
82x82xH65	9108	€ 49,95
84x64xH45	9110	€ 44,95
99x99xH60	9112	€ 49,95
102x82xH65	9114	€ 44,95
105x105xH50	9116	€ 49,95
110x84xH70	9118	€ 44,95
112x82xH50	9120	€ 49,95



Gas barbecues		
126x52xH101	7850	€ 49,95
135x52xH101	7852	€ 54,95
148x61xH110	7854	€ 64,95
165x61x110	7856	€ 69,95



Kettle barbecues		
Ø 47cm	7870	€ 29,95
Ø 57cm	7872	€ 34,95
Ø 67cm	7874	€ 39,95



Fire tables Round		
Ø 50xH60	9140	€ 34,95
Ø 62xH73	9142	€ 39,95
Ø 65xH45	9144	€ 39,95
Ø 72xH58	9146	€ 39,95
Ø 77xH40	9148	€ 39,95
Ø 98xH50	9150	€ 49,95

Parasols



Free-arm parasols		
H250x55/60 (straight pole)	7970	€ 34,95
H240x68 (curved pole)	7971	€ 37,95
H250x85 (curved pole)	7972	€ 44,95
H292x60/65 (straight pole)	7978	€ 49,95



Center pole parasols		
H165x25/35	7982	€ 26,95
H215x30/40	7984	€ 29,95

Accessories



Cover support sets		
Cover support pole set	7810	€ 24,95



Cover support sets		
Cover sandbags (4pcs)	7812	€ 12,95



The protection for your parasol and garden furniture

